

CONTEC®

CT 200

Bodenfräsmaschine
Floor Planer

Betriebsanleitung (Originalausgabe)
Instruction manual (Original edition)



Inhaltsverzeichnis / Index

1. EG-Konformitätserklärung / EC-Declaration of Conformity	...3
2. Anwendungsbereich der Maschine / Machine applications	...4
3. Technische Daten / Technical Data	...4
3.1 Fräse / Planer	...4
3.2 Werkzeuge / Tools	...5
4. Einsatzgebiete der Werkzeuge / Applications of the tools	...5
5. Sicherheitsregeln für den Betrieb der Bodenfräsen / Safety rules	...6
6. Inbetriebnahme und Fräsen / Operating	...6
7. Wechsel der Trommel / Changing the drum	...7
8. Justieren der Frästrommel / Adjusting the drum	...8
9. Wartung und Reinigung / Maintenance and cleaning	...9
9.1 Lager / Bearings	...9
9.2 Gelenke und Höhenverstellung / Height adjustment and joints	...9
9.3 Riementrieb / Belt drive	...9
9.4 Reinigung / Cleaning	...9
10. Skizze / Diagram	...10
11. Anhang / Appendix	...10

EG-Konformitätserklärung

gemäß der EG-Maschinen-Richtlinie 2006/42/EG vom 17. Mai 2006, Anhang II A

Hiermit erklären wir, dass die nachstehend bezeichnete Maschine in ihrer Konzeption und Bauart sowie in der von uns in Verkehr gebrachten Ausführung den grundlegenden Sicherheits- und Gesundheitsanforderungen der EG-Richtlinie 2006/42/EG entspricht. Bei einer mit uns nicht abgestimmten Änderung der Maschine verliert diese Erklärung ihre Gültigkeit.

Hersteller: Contec Maschinenbau & Entwicklungstechnik GmbH, Hauptstraße 146, 57518 Alsdorf, Deutschland

Beschreibung und Identifizierung der Maschine:

Bezeichnung:	Bodenfräse	Modell:	CT 200
Seriennummer:		Baujahr:	

Es wird die Übereinstimmung mit weiteren, ebenfalls für das Produkt geltenden Richtlinien/Bestimmungen erklärt:
EMV-Richtlinie (2004/108/EG) vom 15. Dezember 2004

Angewandte harmonisierte Normen insbesondere:

DIN EN 12100 Sicherheit von Maschinen – Grundbegriffe, allgemeine Gestaltungsleitsätze, : Grundsätzliche Terminologie, Methodik, Risikobeurteilung

DIN EN 60204-1 Sicherheit von Maschinen – Elektrische Ausrüstungen von Maschinen, Teil1: Allgemeine Anforderungen

Bevollmächtigter für die technische Dokumentation: Johannes Greb, Technische Leitung

Alsdorf, 05.03.18



EC-Declaration of Conformity

In accordance with the EEC Machine Directive 2006/42/EG of 17 May 2006, Appendix II A

We hereby certify that the following described machine in its conception, construction and form put by us into circulation is in accordance with all the relevant essential health and safety requirements of the EC Machinery Directive 2006/42/EEC as amended and the national laws and regulations adopting this directive. This declaration is no longer valid if the machine is modified without our consent.

Manufacturer: Contec Maschinenbau & Entwicklungstechnik GmbH, Hauptstraße 146, 57518 Alsdorf, Germany

Description of the machine:

Function:	Floor Planer	Model:	CT 200
Serial number:		Year:	

The agreement with further valid guidelines/regulations following for the products is explained:
EMV-Richtlinie (2004/108/EG) of 15. December 2004

Other applied harmonized standards and specifications in particular:

DIN EN 12100 Sicherheit von Maschinen – Grundbegriffe, allgemeine Gestaltungsleitsätze, : Grundsätzliche Terminologie, Methodik, Risikobeurteilung

DIN EN 60204-1 Sicherheit von Maschinen – Elektrische Ausrüstungen von Maschinen, Teil1: Allgemeine Anforderungen

Authorized person for the technical documentation: Johannes Greb, Technical Manager

Alsdorf, 05.03.18



<h2>2. Anwendungsbereich der Maschine</h2>	<h2>2. Machine applications</h2>
<p>Fräsen von horizontalen, trockenen Böden wie Beton- und Stahlflächen mit und ohne Beschichtung und Asphalt durch Einsatz der von CONTEC[®] angebotenen Fräswerkzeuge. Der Einsatz außerhalb geschlossener Räume ist nur bei trockenem Wetter gestattet. Der Betrieb ist nur mit einer von Contec empfohlenen Absauganlage gestattet.</p>	<p>Planing of horizontal, dry floors such as concrete and steel surfaces with or without a coating and asphalt using CONTEC[®] planing tools. The use of the machine outside is only possible in dry weather. The operation must only be carried out in conjunction with a from Contec recommended dust collector.</p>

<h2>3. Technische Daten</h2>	<h2>3 Technical data</h2>																																																											
<h3>3.1 Fräse</h3> <table border="1" data-bbox="188 999 778 1644"> <tr><td>Arbeitsbreite</td><td>200 mm</td></tr> <tr><td>Maschinenbreite</td><td>36 cm</td></tr> <tr><td>Maschinenlänge</td><td>80 cm</td></tr> <tr><td>Maschinenhöhe</td><td>97 cm</td></tr> <tr><td>Gewicht</td><td>52 kg</td></tr> <tr><td>Absaugstutzen ϕ</td><td>50 mm</td></tr> <tr><td>Höhenverstellung</td><td>Handrad und Hebel</td></tr> <tr><td>Elektromotor</td><td>230 V, 2.0 kW 400 V, 3.0 kW</td></tr> <tr><td>Honda Benziner</td><td>5.5 PS</td></tr> <tr><td>Andere Motoren</td><td>Auf Anfrage</td></tr> <tr><td>Schwingungsgesamtwert a_{hv} *</td><td>6,0 m/s²</td></tr> <tr><td>Schalleistungspegel L_{wa} *</td><td>107 dB(A)</td></tr> <tr><td>Dauerschallpegel Leq *</td><td>97 dB(A)</td></tr> </table>	Arbeitsbreite	200 mm	Maschinenbreite	36 cm	Maschinenlänge	80 cm	Maschinenhöhe	97 cm	Gewicht	52 kg	Absaugstutzen ϕ	50 mm	Höhenverstellung	Handrad und Hebel	Elektromotor	230 V, 2.0 kW 400 V, 3.0 kW	Honda Benziner	5.5 PS	Andere Motoren	Auf Anfrage	Schwingungsgesamtwert a_{hv} *	6,0 m/s ²	Schalleistungspegel L_{wa} *	107 dB(A)	Dauerschallpegel Leq *	97 dB(A)	<h3>3.1 Planer</h3> <table border="1" data-bbox="807 999 1398 1715"> <tr><td>Width of cut</td><td>200 mm (8 in)</td></tr> <tr><td>Width</td><td>36 cm (14 in)</td></tr> <tr><td>Length</td><td>80 cm (31 in)</td></tr> <tr><td>Height</td><td>97 cm (38 in)</td></tr> <tr><td>Weight</td><td>52 kg (115 lbs)</td></tr> <tr><td>Dust port ϕ</td><td>50 mm (2 in)</td></tr> <tr><td>Height adjustment</td><td>Hand wheel and lever</td></tr> <tr> <td rowspan="4">Electric motor</td> <td>Europe</td> <td>USA</td> </tr> <tr> <td>230 V, 2.0 kW, 50 Hz</td> <td>110 V, 1.5 hp, 60 Hz</td> </tr> <tr> <td>400 V, 3.0 kW, 50 Hz</td> <td>230 V, 3.0 hp, 60 Hz</td> </tr> <tr> <td></td> <td></td> </tr> <tr><td>Honda petrol</td><td>5.5 hp</td></tr> <tr><td>Other motors</td><td>On request</td></tr> <tr><td>Average value of acceleration a_{hv} *</td><td>6,0 m/s²</td></tr> <tr><td>Noise level L_{wa} *</td><td>107 dB(A)</td></tr> <tr><td>Noise level Leq *</td><td>97 dB(A)</td></tr> </table>	Width of cut	200 mm (8 in)	Width	36 cm (14 in)	Length	80 cm (31 in)	Height	97 cm (38 in)	Weight	52 kg (115 lbs)	Dust port ϕ	50 mm (2 in)	Height adjustment	Hand wheel and lever	Electric motor	Europe	USA	230 V, 2.0 kW, 50 Hz	110 V, 1.5 hp, 60 Hz	400 V, 3.0 kW, 50 Hz	230 V, 3.0 hp, 60 Hz			Honda petrol	5.5 hp	Other motors	On request	Average value of acceleration a_{hv} *	6,0 m/s ²	Noise level L_{wa} *	107 dB(A)	Noise level Leq *	97 dB(A)
Arbeitsbreite	200 mm																																																											
Maschinenbreite	36 cm																																																											
Maschinenlänge	80 cm																																																											
Maschinenhöhe	97 cm																																																											
Gewicht	52 kg																																																											
Absaugstutzen ϕ	50 mm																																																											
Höhenverstellung	Handrad und Hebel																																																											
Elektromotor	230 V, 2.0 kW 400 V, 3.0 kW																																																											
Honda Benziner	5.5 PS																																																											
Andere Motoren	Auf Anfrage																																																											
Schwingungsgesamtwert a_{hv} *	6,0 m/s ²																																																											
Schalleistungspegel L_{wa} *	107 dB(A)																																																											
Dauerschallpegel Leq *	97 dB(A)																																																											
Width of cut	200 mm (8 in)																																																											
Width	36 cm (14 in)																																																											
Length	80 cm (31 in)																																																											
Height	97 cm (38 in)																																																											
Weight	52 kg (115 lbs)																																																											
Dust port ϕ	50 mm (2 in)																																																											
Height adjustment	Hand wheel and lever																																																											
Electric motor	Europe	USA																																																										
	230 V, 2.0 kW, 50 Hz	110 V, 1.5 hp, 60 Hz																																																										
	400 V, 3.0 kW, 50 Hz	230 V, 3.0 hp, 60 Hz																																																										
Honda petrol	5.5 hp																																																											
Other motors	On request																																																											
Average value of acceleration a_{hv} *	6,0 m/s ²																																																											
Noise level L_{wa} *	107 dB(A)																																																											
Noise level Leq *	97 dB(A)																																																											

3.2 Werkzeuge		3.2 Tools	
Trommeldurchmesser	108 mm	Drum ϕ	108 mm
Wellendurchmesser	12 mm	Cutter shaft ϕ	12 mm
Anzahl d. Wellen pro Trommel	4	Number of shafts	4
Lamelle	46/5	TCT Cutter	46/5
Walzenfräser	46/20	Milling cutter	46/20
Stahllamellen	46	Beam flails	46
Lamellendurchmesser	46 mm	Cutter ϕ	46 mm
Anzahl Lamellen	76	Number of TCT Cutters	76
Anzahl Walzenfräser	24	Number of milling cutters	24

* Messwerte / Data: VÜA Verein zur Überwachung technischer Anlagen e.V.

Änderungen vorbehalten / All specifications are approximate and subject to confirmation.

They should only be used as a guide.

4. Einsatzgebiete der Werkzeuge		4. Applications of the tools	
Hartmetall-Lamellen	Für den harten Einsatz, sehr verschleißfest. Zum Aufrauhren von Beton und Asphalt, Abtragen von Kanten und Überhöhungen, Entfernen v. Beschichtungen, Farbe und Schmutz.	TCT Cutters	Heavy duty, long life cutters for all concrete texturing, scabbling, planing and grooving applications. Also used for removal of road markings, roof chippings and brittle coatings
Walzenfräser	Vorwiegend zum Entfernen von Thermoplast-Straßenmarkierungen auf Asphalt und Beton, Entfernen von Bodenbeschichtungen auf Thermoplastbasis.	Milling cutters	Primarily for the removal of thermoplastic road / runway markings. Tipped with tungsten carbide they are cost effective and highly efficient. A range of cutter dimensions are available.
Stahllamellen	Gehärtete Stahllamellen zum Entfernen von Farbüberzügen und Beschichtungen. Auch zum Entfernen von Fett- und Schmutzschichten.	Beam flails	Heat treated cutters for the removal of paint coatings and laitance from new concrete. Also for removing grease, dirt and ice deposits.

5. Sicherheitsregeln für den Betrieb der Bodenfräsen	5. Safety rules
<p>Achtung! Die Bodenfräse CT 200 ist unter Berücksichtigung geltender Sicherheitsstandards entwickelt worden. Die technischen Sicherheitsvorkehrungen dürfen auf keinen Fall entfernt oder verändert werden. Beim Betrieb der Fräsen sollten außerdem folgende Punkte beachtet werden:</p> <ol style="list-style-type: none"> 1. Die Bodenfräsen dürfen nur mit sämtlichen Schutzvorrichtungen betrieben werden. 2. Der Maschinist darf sich während des Betriebs nicht von der Bodenfräse entfernen 3. Vor dem Verlassen der Bodenfräse hat der Maschinist den Antrieb stillzusetzen und das Gerät gegen ungewollte Bewegungen zu sichern. Bei Elektroantrieben muß außerdem der Netzstecker gezogen werden. 4. Nach Wartungs- und Instandsetzungsarbeiten müssen die Schutzvorrichtungen wieder ordnungsgemäß angebracht werden. 5. Bei Schallpegeln über 90 dB(A) müssen Schallschutzmittel vom Maschinisten getragen werden. <p>Bei größerer Staubentwicklung in geschlossenen Räumen muß die Bodenfräse mit einer Absauganlage betrieben werden.</p>	<p>Attention! The CT 200 floor planers are constructed according to existing safety rules and regulations. These technical precautions should not be removed or changed under any circumstances. While operating the machines the following points should also be kept in mind:</p> <ol style="list-style-type: none"> 1. The planers should always be operated with all safety covers and technical precautions. 2. The operator should never leave the machine during operation. 3. Before leaving the machine all rotary parts should be brought to a stand still. The electric models must be disconnected from the mains. Make sure that the machine cannot roll or move by itself. 4. After maintenance and adjustment all safety covers must be reattached. 5. If the noise level exceeds 90 dB(A) ear protectors must be worn. <p>In the event of a large amount of dust during operation connect a dust collector to the planer.</p>

6. Inbetriebnahme und Fräsen	6. Operating
<p>Nach Montage der für die Anwendung erforderlichen Werkzeuge kann mit dem Arbeiten begonnen werden.</p> <p>Die Fräse mit dem Hebel auf Arbeitsstellung absenken. Die Arbeitstiefe mit dem Handrad der Höhenregulierung soweit einstellen, bis die Werkzeuge auf dem Boden greifen und</p>	<p>After mounting the appropriate tools the operation of the planer can begin.</p> <p>Lower the planer with the lever to the operating position. Turn the hand wheel of the height adjustment until the tools are lowered to the floor and until you achieve the</p>

<p>der gewünschte Effekt erzielt wird.</p> <p>Achtung: Übermäßige Tiefeneinstellung verringert die Schlagkraft der Werkzeuge und bringt keine Leistungssteigerung. Außerdem werden Trommelwellen und Maschinenlager übermäßig belastet und es kann zum Ausfall der Teile führen.</p> <p>Achtung: Der Motor der Fräse darf niemals eingeschaltet werden wenn die Werkzeuge noch den Boden berühren. Immer erst mit dem Lifthebel vom Boden abheben, dann einschalten, absetzen und mit dem Handrad auf die gewünschte Tiefe einstellen.</p> <p>Starke Staubentwicklung kann durch Anschluß einer Absauganlage vermieden werden.</p>	<p>required finish.</p> <p>Attention: Lowering the tools too much decreases the performance of the machine. You will also destroy the shafts in the drum and the bearings of the machine.</p> <p>Attention: Never switch the motor of the planer on while the tools still touch the floor. Always lift the machine and the tools clear from the floor and then switch the motor on.</p> <p>Heavy dust can be avoided by connecting a dust collector to the dust port.</p>
--	---

<h3>7. Wechsel der Trommel</h3>	<h3>7. Changing the drum</h3>
<p>Achtung: Vor Wartungsarbeiten Motor zum Stillstand bringen und bei Elektroausführung Netzstecker ziehen.</p> <ul style="list-style-type: none"> - Maschine mit Lifthebel abheben, damit die Werkzeuge den Boden nicht mehr berühren. - Schrauben am rechten Seitendeckel lösen (M10, Schlüsselweite 17 mm) - Seitendeckel vorsichtig abziehen. - Werkzeugtrommel herausziehen. Verschlossene Werkzeuge ausbauen. Trommelwellen und Trommel selbst auf Verschleiß prüfen. Gegebenenfalls mit neuen Werkzeugen bestücken. - Trommel auf eingefettete Antriebswelle schieben. - Seitendeckel wieder befestigen. 	<p>Attention: Before any maintenance, the machine must be brought to a complete stand still. Always disconnect the machine if it is an electric model.</p> <ul style="list-style-type: none"> - Lift the machine with the lever so that the tools are well clear of the floor. - Unscrew the screws on the right side plate (M10, Key width 17 mm) - Carefully remove the side plate. - Take out the drum. Remove worn out tools. Check shafts and drums for wear and tear. If necessary replace new tools on the drum. - Push drum on freshly greased shaft. - Reconnect side plate.

8. Justieren der Frästrommel	8. Adjusting the drum
<p>Durch Unterschiede in den Frästrommeln und durch Verzug während des Betriebs der Fräse CT 200 können Fluchtfehler zwischen der Hinterradachse und der Frästrommelachse auftreten. Dies macht sich durch ein ungleichmäßiges Fräsbild bemerkbar. Die Fräse setzt auf einer Seite früher auf als auf der anderen und nimmt dadurch mehr Material auf einer Seite ab.</p> <p>Eines der beiden Hinterräder der CT 200 besitzt eine Achse, die exzentrisch ausgebildet ist. (siehe Skizze)</p>	<p>During the operation of the CT 200 floor planer or after a drum has been changed or replaced, the drum shaft and the rear wheel axis can fall out of alignment. This results in an uneven track on the floor. On one side the drum touches the floor before the other and therefore removes more surface material on this side.</p> <p>One of the two rear wheels is mounted on an eccentric shaft (see diagram).</p>

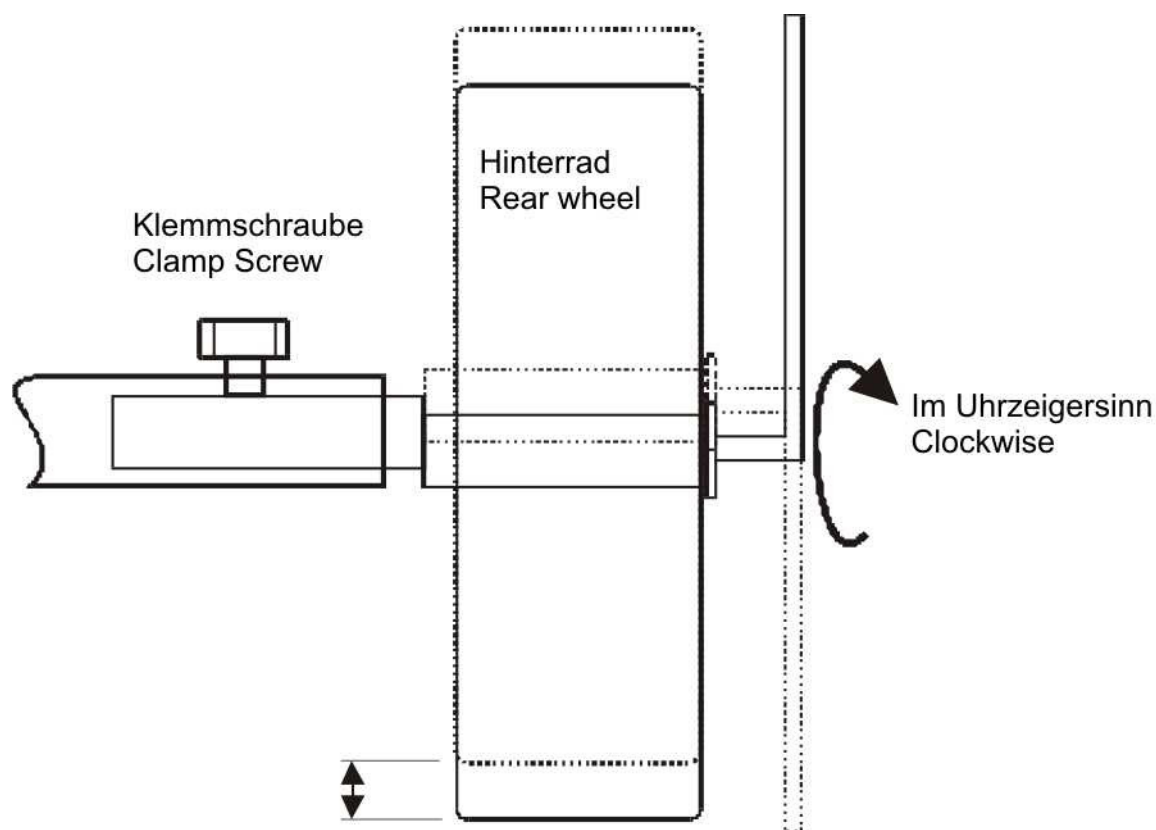

<p>Falls das Fräsbild eingestellt werden muß, gehen Sie wie folgt vor: Fahren Sie die Fräsmaschine auf eine ebene Fläche. Drehen Sie die Maschine mittels des Handrades so weit hoch, bis alle Werkzeuge den Kontakt</p>	<p>If the drum has to be adjusted proceed as follows: Place the planer on an even floor. Lift the machine with the height adjustment hand wheel, until all the tools are well clear of the</p>
--	--

<p>zum Boden verlieren. Lösen Sie die Klemmschraube der Exzenterachse. Auf der äußeren Seite des Hinterrades befindet sich eine Schraube, mit der das Rad auf der Welle gehalten wird. Durch drehen der Schraube wird sich auch die Exzenterachse drehen und die Fräsmaschine sich auf und wieder abbewegen. Um ein lösen der Schraube zu verhindern, drehen Sie immer in Uhrzeigerrichtung. Drehen Sie so lange an der Welle bis sich die Werkzeuge der Frästrommel alle mit dem gleichen Abstand zum Boden befinden. Ziehen Sie die Klemmschraube der Exzenterachse wieder an.</p>	<p>floor. Loosen the clamping screw of the eccentric shaft. On the other side of the rear wheel is a screw which keeps the wheel on the shaft. Turning the screw will also turn the eccentric shaft. The floor planer moves up and down on one side. Always turn the screw clockwise. Anti clockwise would loosens the screw. Keep turning until all the tools on the drum are the same distance to the floor. Tighten the clamping screw again.</p>
--	--

<h2>9. Wartung und Reinigung</h2>	<h2>9. Maintenance and cleaning</h2>
<p>9.1 Lager Alle Kugellager sind auf Lebensdauer geschmiert.</p> <p>9.2 Gelenke und Höhenverstellung Alle Gelenke sind periodisch mit handelsüblichem Maschinenfett zu schmieren.</p> <p>9.3 Riementrieb Die Riemen sind in Intervallen von ungefähr 30 Betriebsstunden zu überprüfen und ggf. auszuwechseln. Die Riemenspannung erfolgt über Anhebung der Motorhalteplatte. Dazu müssen die 4 M10er Schrauben der Halteplatte gelöst werden. Die vorderen Schrauben sind in einem Langloch angebracht. Durch Anheben der Motorhalteplatte werden die Riemen gespannt. Danach müssen die Schrauben wieder fest angezogen werden.</p> <p>9.4 Reinigung Eine regelmäßige Reinigung der Maschine erhöht die Lebensdauer aller Maschinenkomponenten und Werkzeuge.</p>	<p>9.1 Bearings All bearings are greased for their life time.</p> <p>9.2 Height adjustment and joints All joints have to be greased periodically with a standard machine grease.</p> <p>9.3 Belt drive Check the belts after approximately every 30 hours of operation. To tension the belt you need to raise the motor bracket. Loosen the 4 M10 screws of the bracket. The front screws are in two slots. Raise the bracket until the belts are tensioned. Tighten the screws again.</p> <p>9.4 Cleaning Regular cleaning of the machine increases the life of all components and tools of the planer.</p>

10. Skizze

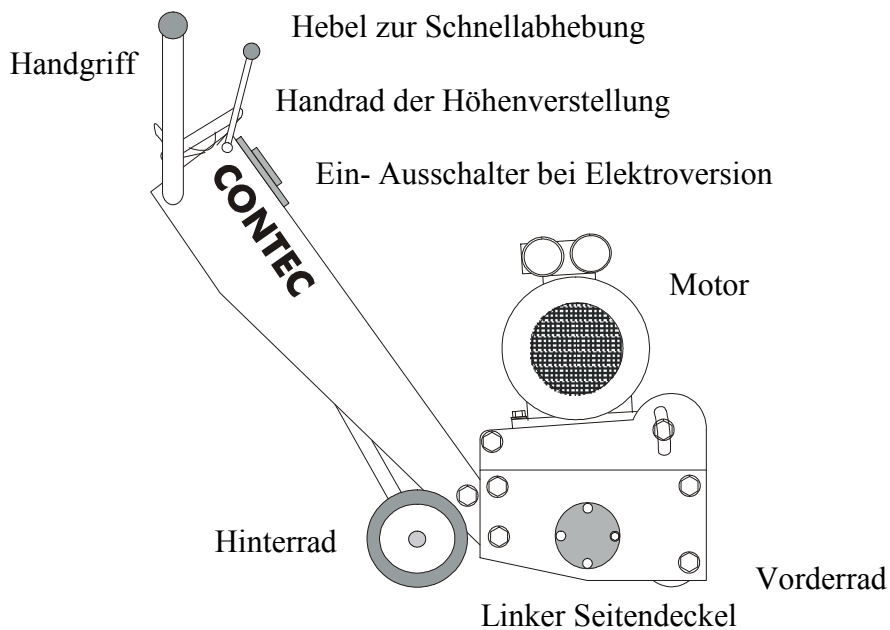

Diagram

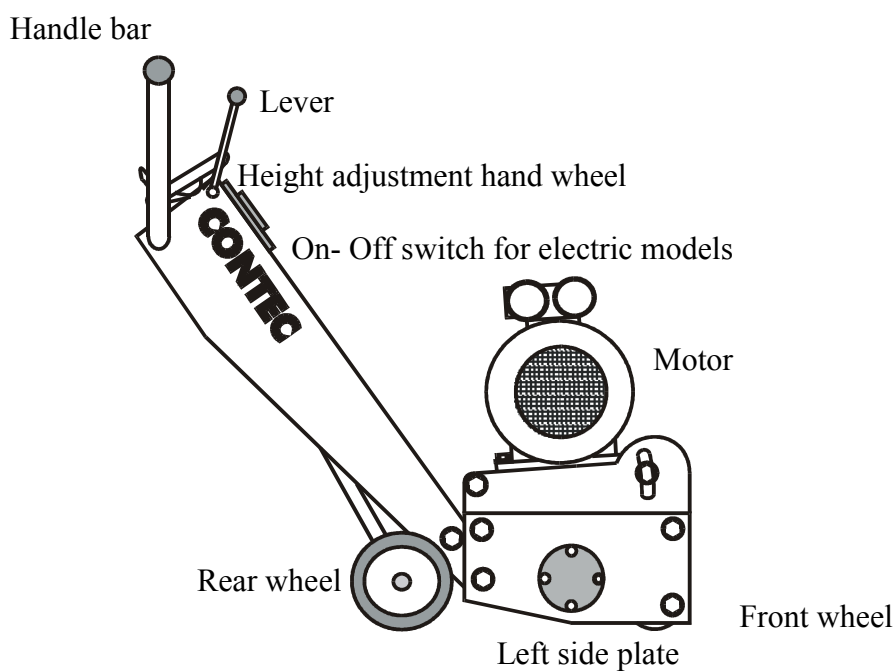

11. Anhang

Explosionszeichnung (Skizze) / Diagrams

Verdrahtungsplan / Wire diagram

Werkzeuge / Tools

Teileliste / Parts list

CT 200-230: 230V, 50Hz, 1 Phase

CT 200-230 US: 230V, 60Hz, 1 Phase

CT 200-400: 400V, 50Hz, 3 Phase

CT 200 P: Benzin / Petrol version

CT 200 - Honda
(c) Contec GmbH 2018

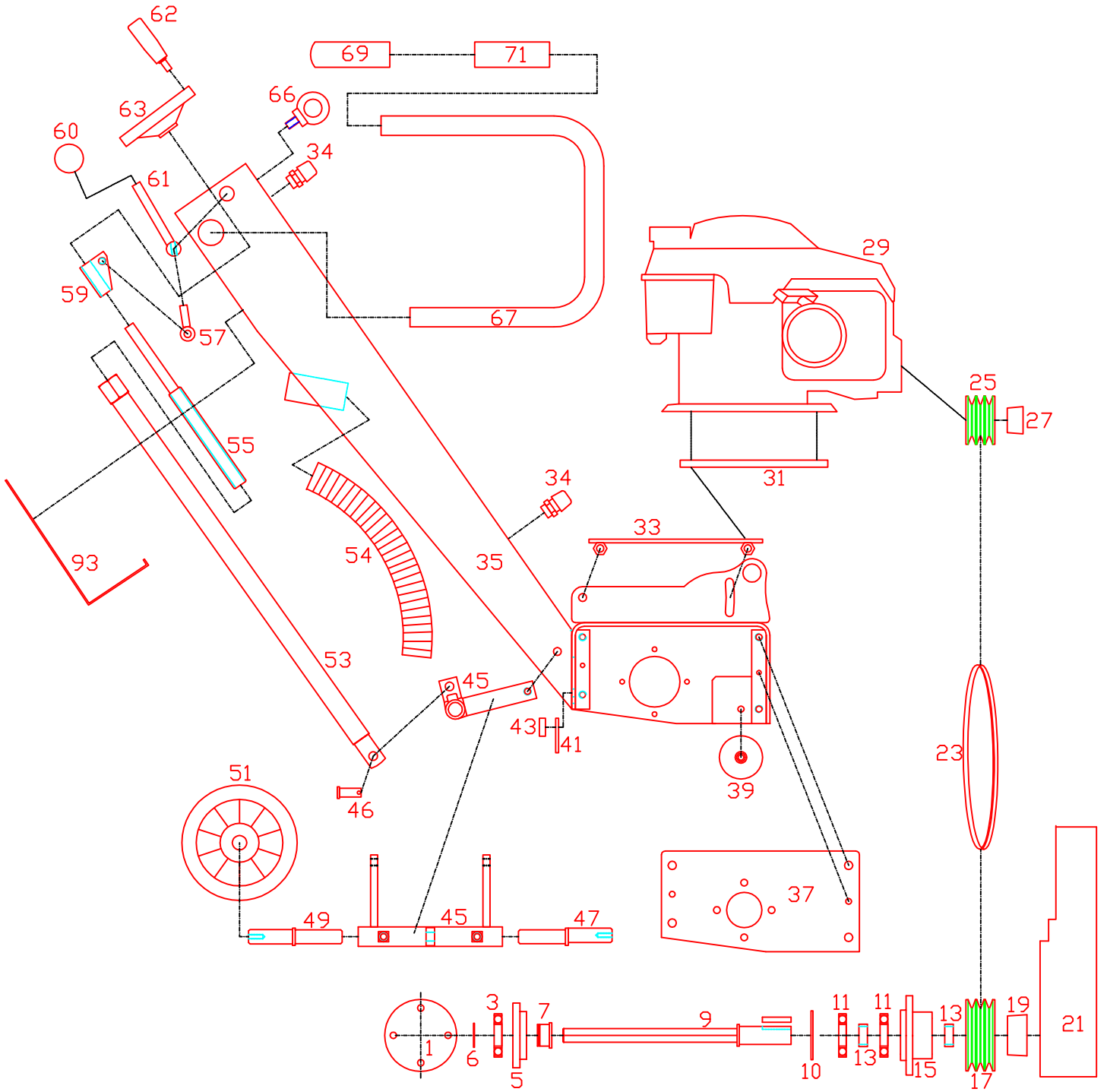

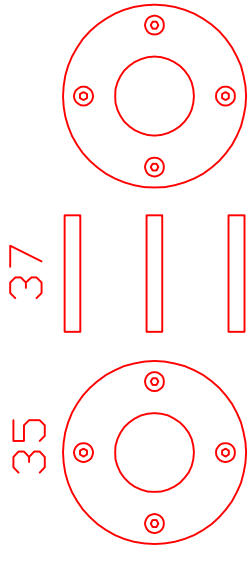

31  24 Lamellen /
 24 cutters /
 24 Scheiben /
 24 spacers

33  12 Schälamellen /
 12 milling flails /
 28 Scheiben /
 28 spacers

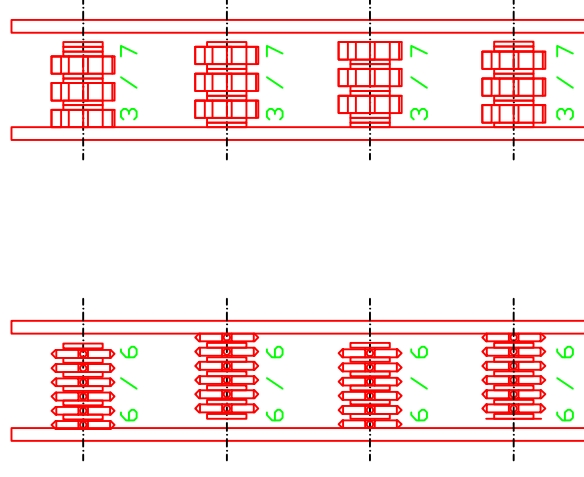
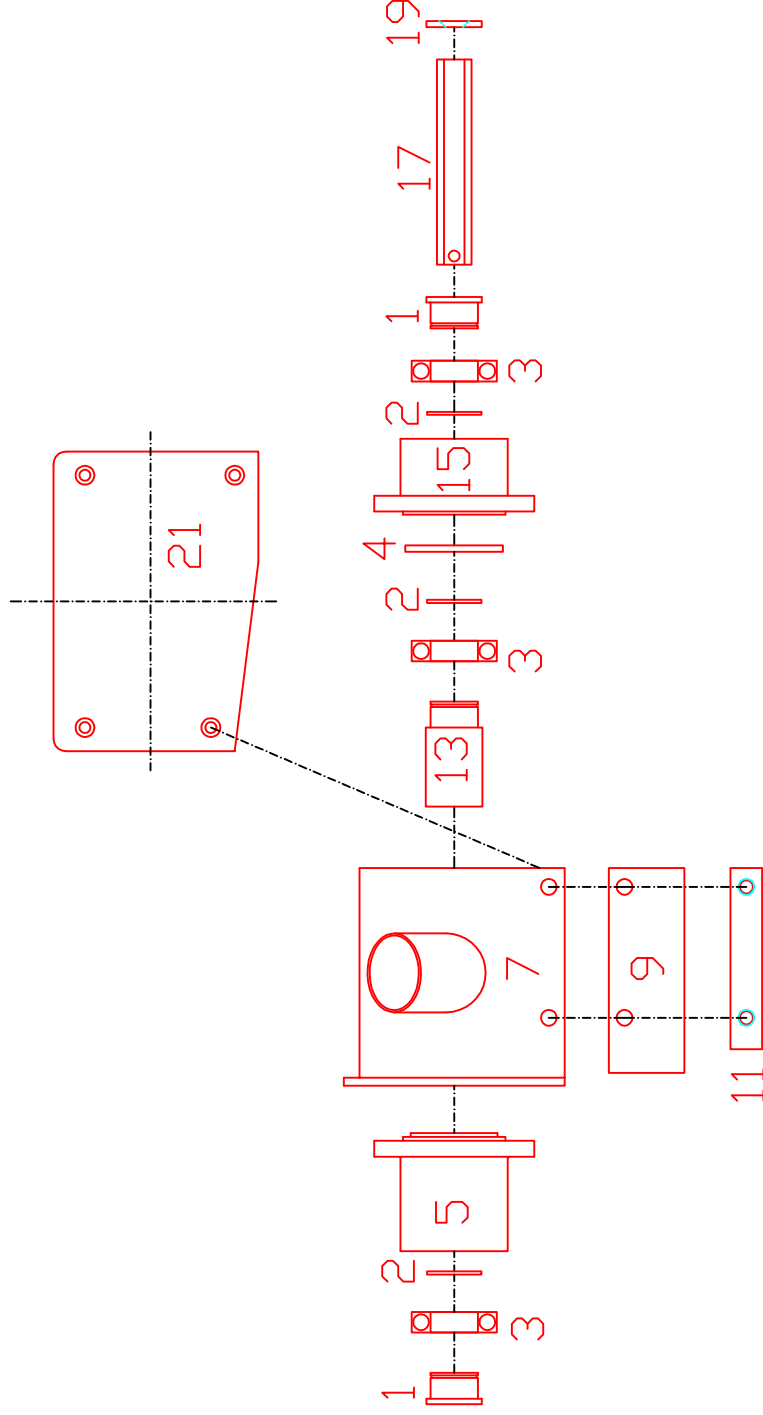

41 Trommel / drum

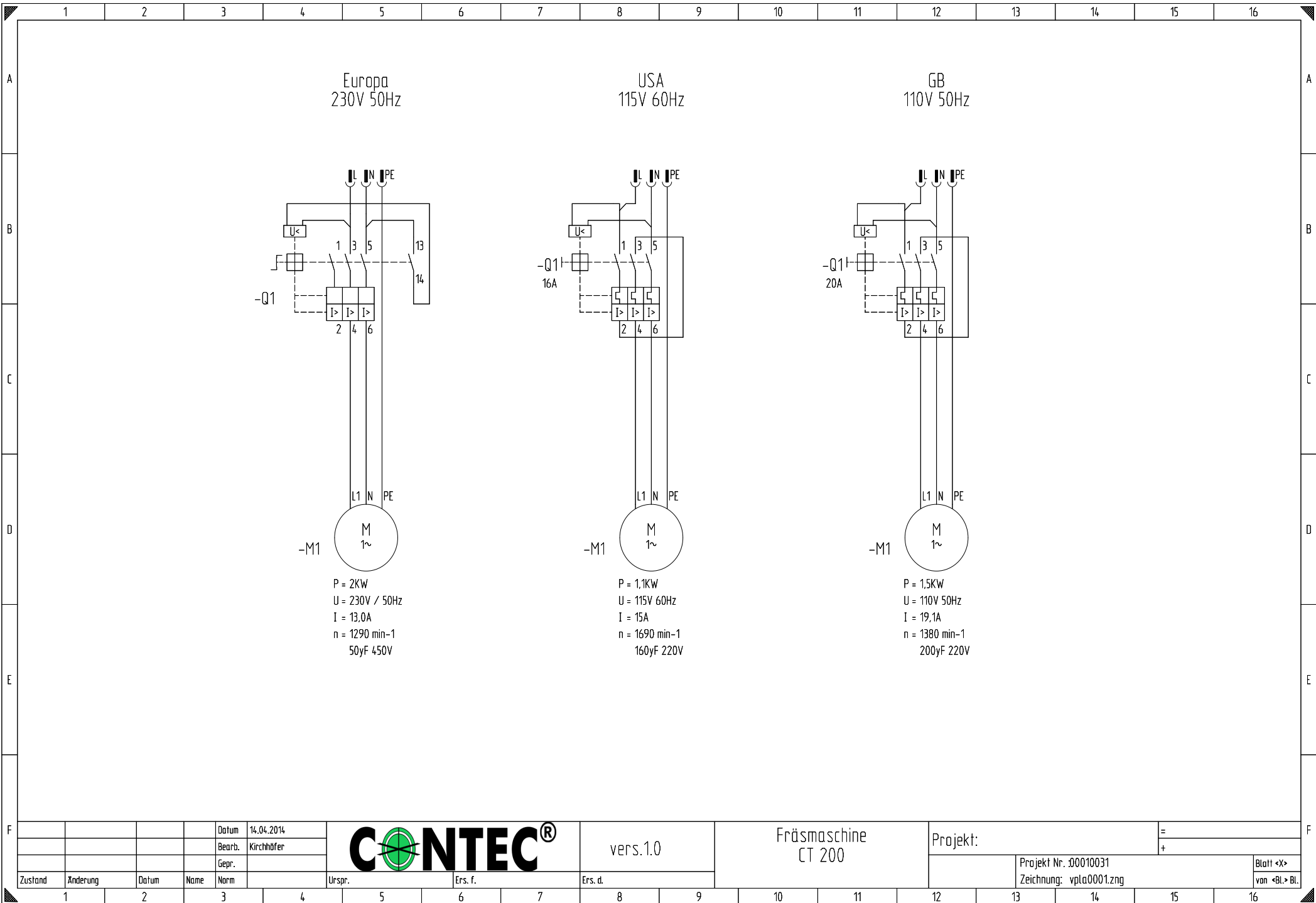

Datum	14.04.2014
Bearb.	Kirchhöfer
Gepr.	
Zustand	Anderung
Datum	Name
Norm	Urspr.
Ers. f.	Ers. d.



vers.1.0

Fräsmaschine
CT 200

Projekt: =
+
Projekt Nr. 00010031
Zeichnung: vpla0001.zng
Blatt <X>
van <Bl> Bl.

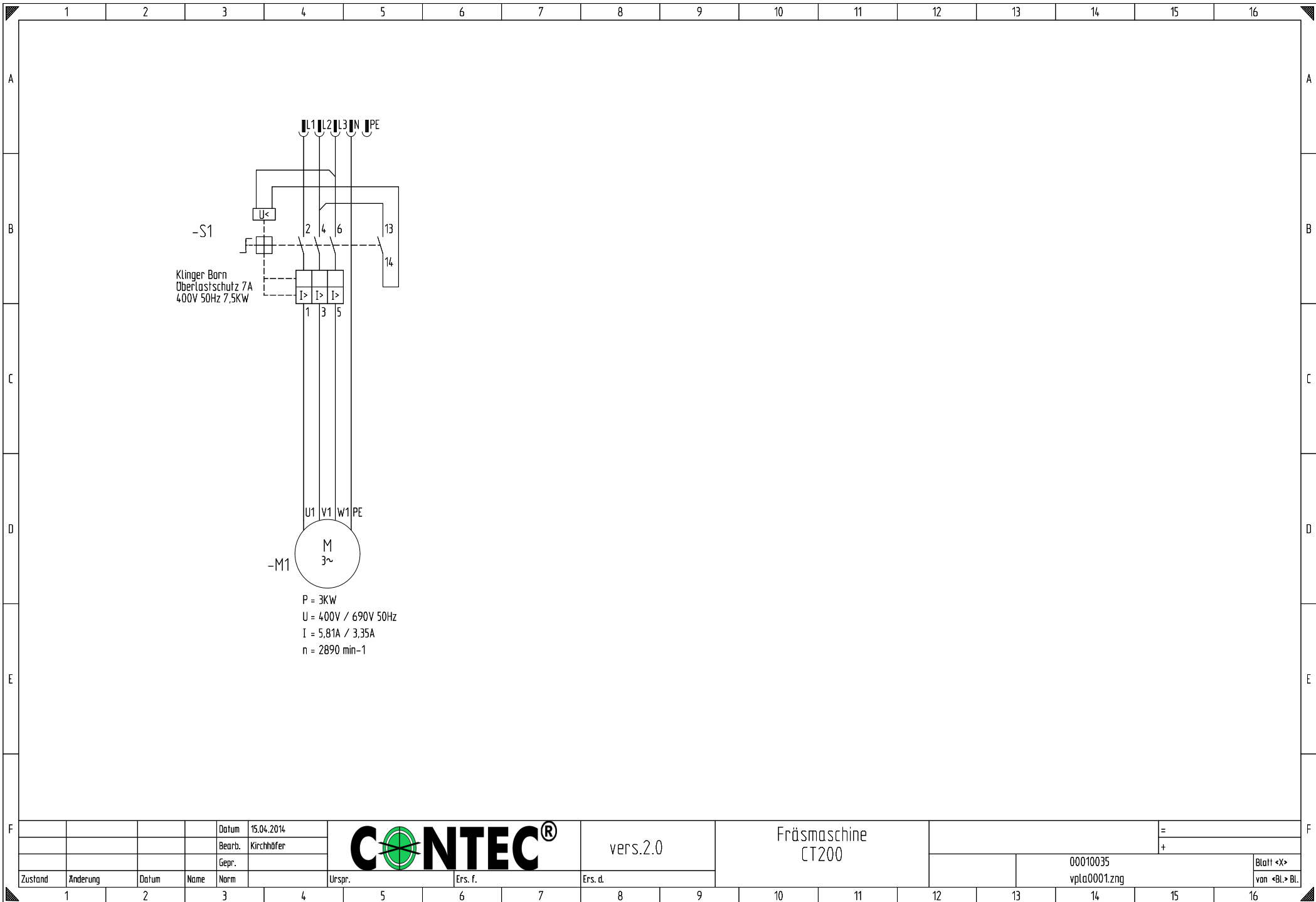

			Datum	15.04.2014
			Bearb.	Kirchhofer
			Gepr.	
Zustand	nderung	Datum	Name	Norm
			Urspr.	Ers. f.



vers.2.0

Frasmaschine
CT200

			=	
			+	
			00010035	Blatt <X>
			vpla0001.zng	van <Bl> Bl.

Werkzeuge für CT 200
 Tools for CT 200
 (c) Contec GmbH 2014

100 Trommel / drum

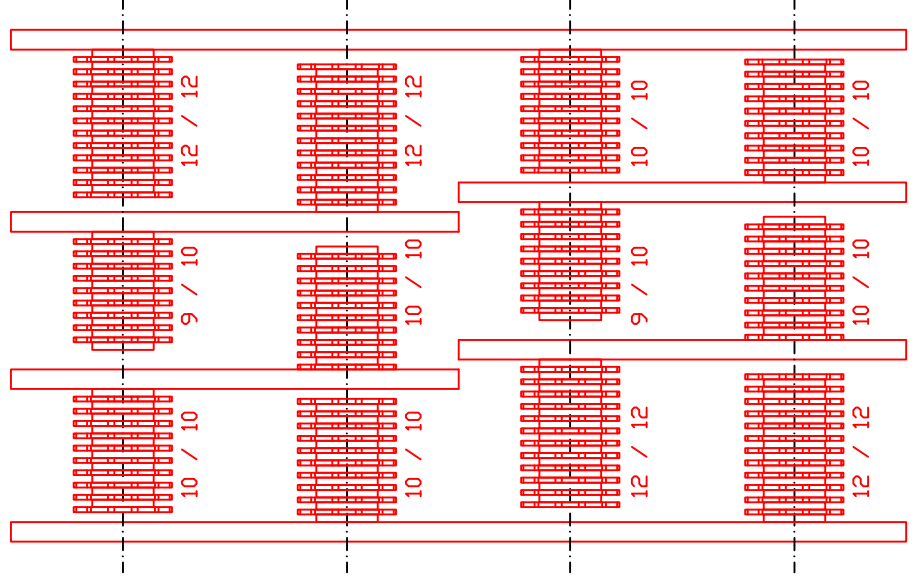
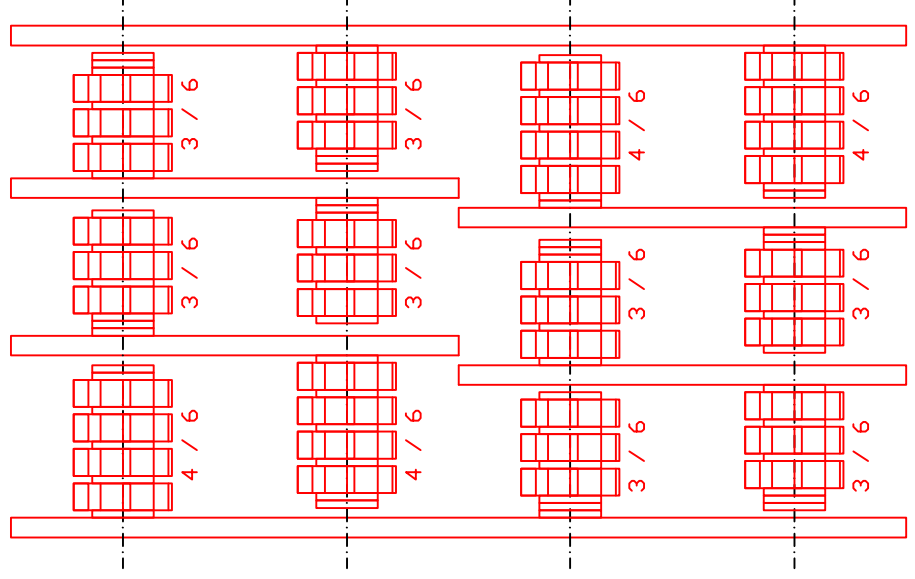
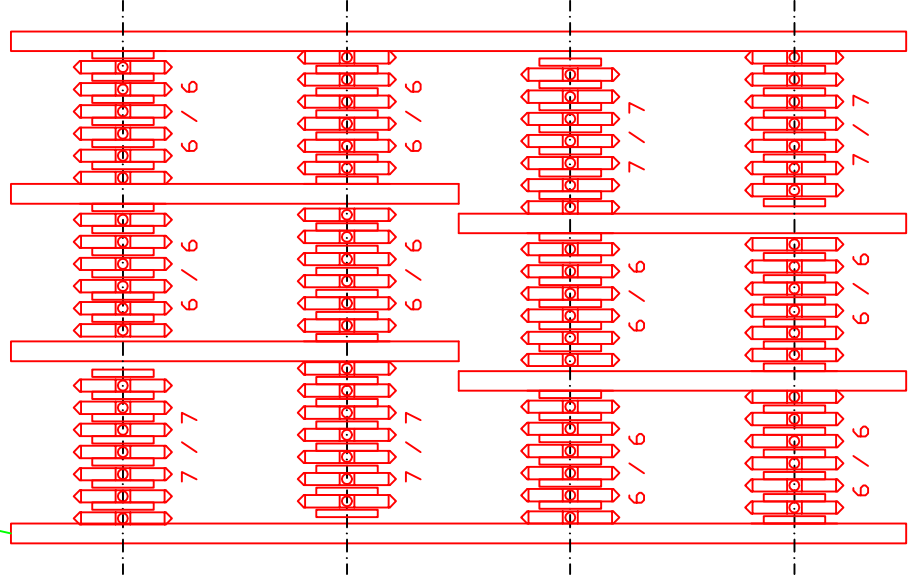
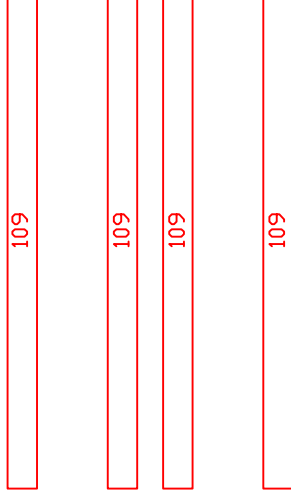

Pos.	Teilenummer Part No.	Bezeichnung	Description	Menge Quantity
001	17-10-05-01	Lagerdeckel rechts	Lid Bearing Housing	1
003	61-20-60-06	Kugellager	Bearing	1
005	17-17-05-02	Lagergehäuse rechts	Right Bearing Housing	1
006	61-30-00-30	Sicherungsring	Circlip	1
007	17-21-07-02	Sechskantbuchse	Hexagon Bush	1
009	17-21-07-01	Trommelwelle	Drum Shaft	1
010	61-30-01-47	Sicherungsring	Circlip	1
011	61-20-60-05	Kugellager	Bearing	2
013	17-10-07-03	Lagergehäuse Distanzring	Spacer Bearing Housing	2
015	17-17-06-01	Lagergehäuse links	Left Bearing Housing	1
017	90-24-95-3TB	Riemenscheibe	Drum Pulley	1
019	90-24-16-10-25	Taperlock	Taperlock	1
021	17-10-04-00	Riemenschutz CT200	Belt Cover CT200	1
023	70-24-10-710	Keilriemen	Belt	3
025	90-24-63-3TB	Riemenscheibe	Motor Pulley	1
027	90-24-11-08-24	Taperlock	Taperlock	1
029	55-03-00-20	Motor	Motor	1
031	17-10-10-01	Flacheisen	Motor Spacer	2
033	17-10-02-01	Motorhalteplatte	Motor Bracket	1
034	50-20-23-M-20	Kabelverschraubung	Cable Gland	2
035	17-10-01-00	Maschinenrahmen	Machine Frame	1
037	17-10-01-02	Seitendeckel	Side Plate	1
039	80-20-60-40	Vorderrad	Front Wheel	1
041	70-23-02-30	Fräsfeldabdichtung	Rubber Sealing	1
043	17-10-11-01	Flacheisen Fräsfeldabdichtung	Bracket for Rubber Sealing	1
045	17-10-09-01	Hinterradschwinge	Rear Swing Arm	1
046	60-33-12-25	Bolzen für Gabelkopf	Pin for lifting Rod	1
047	30-10-08-05	Achsbolzen Exzenter	Eccentric Axis	1
049	30-10-08-04	Achsbolzen	Axis	1
051	80-20-31-60	Hinterrad	Wheel	2
053	17-10-08-03	Rohr Höhenverstellung	Lifting Rod	1
054	70-25-03-50	Absaugschlauch	Dusthose	1
055	17-10-08-02	Gewindespindel	Height Adjustment Spindle	1
057	61-50-10-40	Augenschraube	Eye Screw	1
059	17-10-08-01	Spindelmutter	Spindle Nut	1
060	90-21-45-12	Kugelknopf	Ball Head	1
061	17-10-13-01	Hebel Höhenverstellung	Lever Height Adjustment	1
062	90-21-95-51	Zylindergriff Handrad	Knob for Handwheel	1
063	90-21-95-50	Handrad	Level Adjustment Wheel	1
065	50-20-10-56	Einschalter	Switch	1
066	580 C15 M10 VZ	Ringschraube	Ring Bolt	2
067	18-10-07-01	Griffrohr	Handle Pipe	1
069	70-21-26-10	Griffgummi	Rubber Grip	1
071	70-21-26-11	Griffgummi offen	Rubber Grip open	1
093	18-10-01-05	Gehäusedeckel rückseitig	Handle Arm Cover	1
100	95-10-200-T	Frästrommel	Drum	1
101	95-16-45-05	Fräslamellen 45/5	TC Cutters 45 / 5	1
103	95-16-42-10	Schällamelle 42 / 10	Milling Flail 42 / 10	1
105	95-16-42-12	Strahlenlamelle 42 / 12	Beam Flails 42 / 12	1

Pos.	Teilenummer Part No.	Bezeichnung	Description	Menge Quantity
107	95-16-24-13	Frästrommel Scheibe	Spacer	1
109	95-10-200-A	Frästrommel Achsen	Axis for Drum	4
111	95-10-200-S	Frästrommel Seitenscheibe	Drum Side Disc	2
121	90-20-00-24	Zugentlastung	Strain Relief	1

Pos.	Teilenummer Part No.	Bezeichnung	Description	Menge Quantity
001	17-10-05-01	Lagerdeckel rechts	Lid Bearing Housing	1
003	61-20-60-06	Kugellager	Bearing	1
005	17-17-05-02	Lagergehäuse rechts	Right Bearing Housing	1
006	61-30-00-30	Sicherungsring	Circlip	1
007	17-21-07-02	Sechskantbuchse	Hexagon Bush	1
009	17-21-07-01	Trommelwelle	Drum Shaft	1
010	61-30-01-47	Sicherungsring	Circlip	1
011	61-20-60-05	Kugellager	Bearing	2
013	17-10-07-03	Lagergehäuse Distanzring	Spacer Bearing Housing	2
015	17-17-06-01	Lagergehäuse links	Left Bearing Housing	1
017	90-24-95-3TB	Riemenscheibe	Drum Pulley	1
019	90-24-16-10-25	Taperlock	Taperlock	1
021	17-10-04-00	Riemenschutz CT200	Belt Cover CT200	1
023	70-24-10-710	Keilriemen	Belt	3
025	90-24-63-3TB	Riemenscheibe	Motor Pulley	1
027	90-24-11-08-28	Taperlock	Taperlock	1
029	55-03-00-30	Motor	Motor	1
033	17-10-02-01	Motorhalteplatte	Motor Bracket	1
034	50-20-23-M-20	Kabelverschraubung	Cable Gland	2
035	17-10-01-00	Maschinenrahmen	Machine Frame	1
037	17-10-01-02	Seitendeckel	Side Plate	1
039	80-20-60-40	Vorderrad	Front Wheel	1
041	70-23-02-30	Fräsfeldabdichtung	Rubber Sealing	1
043	17-10-11-01	Flacheisen Fräsfeldabdichtung	Bracket for Rubber Sealing	1
045	17-10-09-01	Hinterradschwinge	Rear Swing Arm	1
046	60-33-12-25	Bolzen für Gabelkopf	Pin for lifting Rod	1
047	30-10-08-05	Achsbolzen Exzenter	Eccentric Axis	1
049	30-10-08-04	Achsbolzen	Axis	1
051	80-20-31-60	Hinterrad	Wheel	2
053	17-10-08-03	Rohr Höhenverstellung	Lifting Rod	1
054	70-25-03-50	Absaugschlauch	Dusthose	1
055	17-10-08-02	Gewindespindel	Height Adjustment Spindle	1
057	61-50-10-40	Augenschraube	Eye Screw	1
059	17-10-08-01	Spindelmutter	Spindle Nut	1
060	90-21-45-12	Kugelknopf	Ball Head	1
061	17-10-13-01	Hebel Höhenverstellung	Lever Height Adjustment	1
062	90-21-95-51	Zylindergriff Handrad	Knob for Handwheel	1
063	90-21-95-50	Handrad	Level Adjustment Wheel	1
065	50-20-10-57	Einschalter	Switch	1
066	580 C15 M10 VZ	Ringschraube	Ring Bolt	2
067	18-10-07-01	Griffrohr	Handle Pipe	1
069	70-21-26-10	Griffgummi	Rubber Grip	1
071	70-21-26-11	Griffgummi offen	Rubber Grip open	1
093	18-10-01-05	Gehäusedeckel rückseitig	Handle Arm Cover	1
100	95-10-200-T	Frästrommel	Drum	1
101	95-16-45-05	Fräslamellen 45/5	TC Cutters 45 / 5	1
103	95-16-42-10	Schällamelle 42 / 10	Milling Flail 42 / 10	1
105	95-16-42-12	Strahlenlamelle 42 / 12	Beam Flails 42 / 12	1
107	95-16-24-13	Frästrommel Scheibe	Spacer	1

Pos.	Teilenummer Part No.	Bezeichnung	Description	Menge Quantity
109	95-10-200-A	Frästrommel Achsen	Axis for Drum	4
111	95-10-200-S	Frästrommel Seitenscheibe	Drum Side Disc	2

Pos.	Teilenummer Part No.	Bezeichnung	Description	Menge Quantity
001	17-10-05-01	Lagerdeckel rechts	Lid Bearing Housing	1
003	61-20-60-06	Kugellager	Bearing	1
005	17-17-05-02	Lagergehäuse rechts	Right Bearing Housing	1
006	61-30-00-30	Sicherungsring	Circlip	1
007	17-21-07-02	Sechskantbuchse	Hexagon Bush	1
009	17-21-07-01	Trommelwelle	Drive Shaft	1
010	61-30-01-47	Sicherungsring	Circlip	1
011	61-20-60-05	Kugellager	Bearing	2
013	17-10-07-03	Lagergehäuse Distanzring	Spacer Bearing Housing	2
015	17-17-06-01	Lagergehäuse links	Left Bearing Housing	1
017	90-24-95-3TB	Riemenscheibe	Drum Pulley	1
019	90-24-16-10-25	Taperlock	Taperlock	1
021	17-10-04-00	Riemenschutz CT200	Belt Cover CT200	1
023	70-24-10-737	Keilriemen	Belt	3
025	90-24-63-3TB	Riemenscheibe	Motor Pulley	1
027	90-24-11-08-HONI	Taperlock	Taperlock	1
029	56-GX-160-K1-4	Motor Honda	Engine Honda	1
031	17-10-10-01-H	Flacheisen	Engine Spacer	2
033	17-10-02-01	Motorhalteplatte	Motor Bracket	1
034	50-20-23-M-20	Kabelverschraubung	Cable Gland	2
035	17-10-01-00	Maschinenrahmen	Machine Frame	1
037	17-10-01-02	Seitendeckel	Side Plate	1
039	80-20-60-40	Vorderrad	Front Wheel	1
041	70-23-02-30	Fräsfeldabdichtung	Rubber Sealing	1
043	17-10-11-01	Flacheisen Fräsfeldabdichtung	Bracket for Rubber Sealing	1
045	17-10-09-01	Hinterradschwinge	Rear Swing Arm	1
046	60-33-12-25	Bolzen für Gabelkopf	Pin for lifting Rod	1
047	30-10-08-05	Achsbolzen Exzenter	Eccentric Axis	1
049	30-10-08-04	Achsbolzen	Axis	1
051	80-20-31-60	Rad	Wheel	2
053	17-10-08-03	Rohr Höhenverstellung	Lifting Rod	1
054	70-25-03-50	Absaugschlauch	Dusthose	1
055	17-10-08-02	Gewindespindel	Height Adjustment Spindle	1
057	61-50-10-40	Augenschraube	Eye Screw	1
059	17-10-08-01	Spindelmutter	Spindle Nut	1
060	90-21-45-12	Kugelknopf	Ball Head	1
061	17-10-13-01	Hebel Höhenverstellung	Lever Height Adjustment	1
062	90-21-95-51	Zylindergriff Handrad	Knob for Handwheel	1
063	90-21-95-50	Handrad	Level Adjustment Wheel	1
066	580 C15 M10 VZ	Ringschraube	Ring Bolt	2
067	18-10-07-01	Griffrohr	Handle Pipe	1
069	70-21-26-10	Griffgummi	Rubber Grip	1
071	70-21-26-11	Griffgummi offen	Rubber Grip open	1
093	18-10-01-05	Gehäusedeckel rückseitig	Handle Arm Cover	1
100	95-10-200-T	Frästrommel	Drum	1
101	95-16-45-05	Fräslamellen 45 / 5	TC Cutters 45 / 5	1
103	95-16-42-10	Schälllamelle 42 / 10	Milling Flail 42 / 10	1
105	95-16-42-12	Strahlenlamelle 42 / 12	Beam Flails 42 / 12	1
107	95-16-24-13	Frästrommel Scheibe	Spacer	1

Pos.	Teilenummer Part No.	Bezeichnung	Description	Menge Quantity
109	95-10-200-A	Frästrommel Achsen	Axis for Drum	4
111	95-10-200-S	Frästrommel Seitenscheibe	Drum Side Disc	2

Pos.	Teilenummer Part No.	Bezeichnung	Description	Menge Quantity
001	17-21-07-02	Sechskantbuchse	Hexagon Bush	2
002	61-30-00-30	Sicherungsring	Circlip	3
003	61-20-60-06	Kugellager	Bearing	3
004	472-47	Sicherungsring	Circlip	1
005	17-17-13-01	Lagereinheit Hauptrahmen	Bearing Housing main Frame	1
007	17-10-12-00	Seitenfräse Rahmen	Edger Frame	1
009	70-23-02-31	Dichtgummi	Rubber Sealing	1
011	17-10-12-05	Flacheisen Gummileiste	Bracket Rubber Sealing	1
013	17-21-13-04	Verbinder Trommelwelle	Connector Drum Axis	1
015	17-17-13-02	Lagereinheit	Bearing Housing	1
017	17-21-13-02	Trommelwelle	Drum Axis	1
019	17-10-12-06	Scheibe Wellenende	Washer Drum Axis	1
021	17-10-12-02	Deckel Seitenfräse	Edger Lid	1
031	95-16-45-05	Fräslamellen 45 / 5	TC Cutters 45 / 5	1
033	95-16-24-13	Frästrommel Scheibe	Spacer	1
035	95-10-200-S	Frästrommel Seitenscheibe	Drum Side Disc	2
037	95-10-60-A	Frästrommel Achsen	Shaft for Drum	4
039	95-16-42-10	Schällamelle 42 / 10	Milling Flail 42 / 10	1
041	95-10-60-T	Frästrommel	Drum	1